

Features

- 122 airjets release thousands of heated bubbles that surround, support, and massage the body.
- Variable-speed blower lets you adjust massage intensity to 18 levels.
- Built-in heater.
- Automatic and manual purge cycles remove residual water from air channels after use.
- 60-minute automatic shutoff timer.
- Slotted overflow allows for deep soaking.
- Oval basin creates a spacious bathing experience.
- Spacious design accommodates up to two bathers.
- Wide ledge on one side is ideal for deck-mount faucet and/or handshower.
- Integral lumbar support.
- Keypad control.
- Textured bottom surface.

Material

- Acrylic.

Technology

- Heated BubbleMassage™ technology warms and humidifies air before it enters the bath.

Installation

- Drop-in or undermount.
- Center drain.
- 120 V electrical requirement allows for easy installation with standard outlet.
- Requires one dedicated circuit.

Required Products/Accessories

K-7271 Brass Slotted Overflow Bath Drain

or

K-7272 PVC Slotted Overflow Bath Drain

Recommended Products/Accessories

K-1491 Bath/Whirlpool Pillow
 K-883 Under-Mount Installation Kit
 K-1601 Bath/whirlpool footstop, removable
 K-9498 3" Keypad Trim
 K-24916 Wireless Music Kit
 K-1705 Whirlpool/BubbleMassage™ Remote Control
 K-702200-G73 Frameless Sliding Bath Door
 K-702200-L Frameless Sliding Bath Door
 K-706000-D3 Frameless Sliding Bath Door
 K-706000-L Frameless Sliding Bath Door
 K-706003-L Frameless Sliding Bath Door
 K-706004-D3 Frameless Sliding Bath Door
 K-706004-L Frameless Sliding Bath Door
 K-706007-L Frameless Sliding Bath Door



Codes/Standards







ASME A112.19.7/CSA B45.10
 CSA B45.5/IAPMO Z124
 ASTM E162
 ASTM E662
 UL 1795
 CSA C22.2 No. 218.2

KOHLER® Hydrotherapy Components Five-Year Limited Warranty

See website for detailed warranty information.

Available Colors/Finishes

Color tiles intended for reference only.

| Color | Code | Description |
|---|------|---------------|
|  | 0 | White |
|  | 96 | Biscuit |
|  | NY | Dune |
|  | 95 | Ice™ Grey |
|  | 58 | Thunder™ Grey |
|  | 7 | Black Black™ |

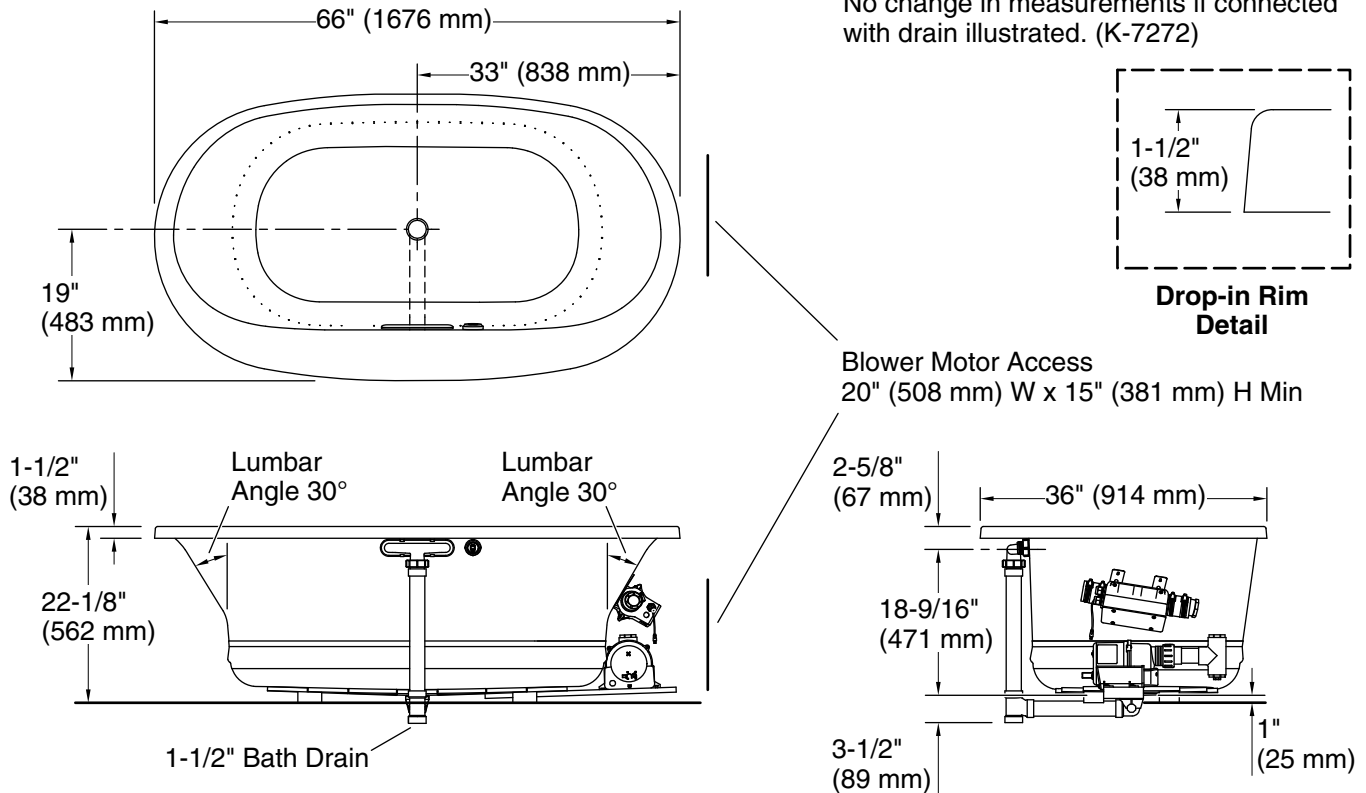

Required Electrical Service

Two dedicated circuits required, protected with Class A Ground-Fault Circuit-Interrupter (GFCI). Outside North America, this device may be known as a Residual Current Device (RCD).

Blower: 120 V, 15 A, 60 Hz
Air bath: 120 V, 15 A, 60 Hz

Technical Information

All product dimensions are nominal.

Installation: Drop-in, Undermount
Drain location: Center
Basin area, bottom: 47" x 26-1/4" (1193 mm x 666 mm)
Basin area, top: 61-3/16" x 28-3/8" (1554 mm x 721 mm)
Weight: 90 lbs (40.8 kg)
Minimum floor load: 84.9 lbs/ft² (414.5 kg/m²)
Water depth: 17-9/16" (446 mm)
Water capacity: 85.5 gal (323.7 L)
Template: Drop-in, 1268439-7, required, included
Electrical component rating: Blower: 120 V, 10 A, 60 Hz
Air bath: 120 V, 5 A, 60 Hz
Blower speed: Variable

Notes

Measure your actual product for rough-in details.

Install this product according to the installation instructions.

The hot water supply should be 70% of the capacity of the bath or greater. Installations will vary.